

C-73-40

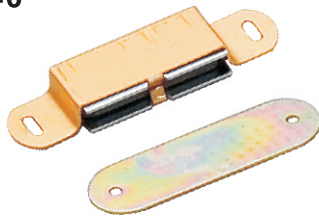

C-73-40

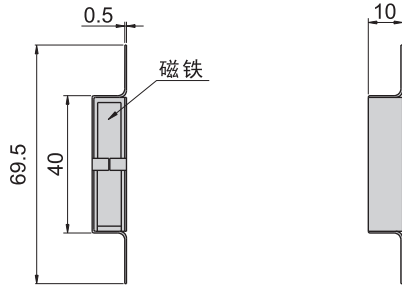

C-73-60

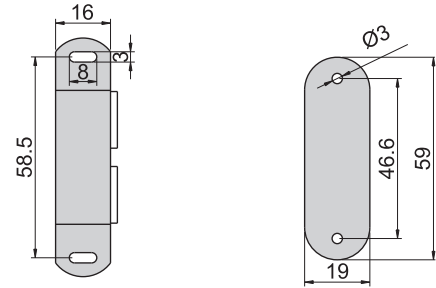
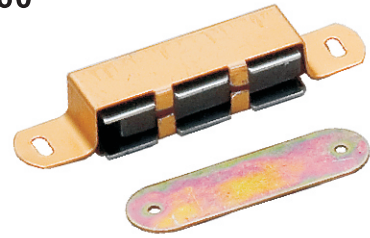

C-73-60

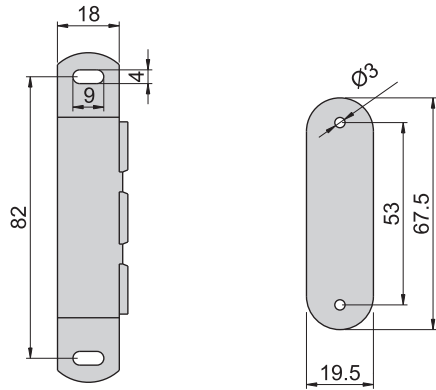
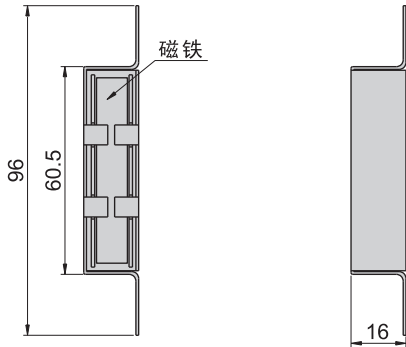

| | |
|------|---------|
| 材 质 | 外壳---铝制 |
| 表面处理 | 电镀五彩 |

强力磁石

C-56-B-2-1

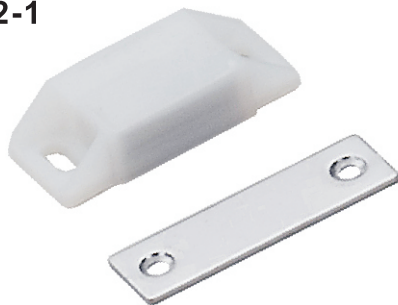

| | |
|------|-------------|
| 材 质 | 塑料壳---PE606 |
| 表面处理 | 挡片---铁 |
| | 挡片---镀锌 |

